

Resource pack

CORE Community Preschool acknowledges the difficult times that people are experiencing due to COVID-19. To support our families, we have created a resource pack for children to continue to engage in learning while staying home.

The resource pack is made up of various paper activities such as name and letter tracing, spot the differences and join the dots. This will promote problem solving and parent participation. Another alternative is free online resources such as iTrace (handwriting for kids) or

<https://www.abc.net.au/kidslisten/ideas/artandcraft/penguin-craft-video/110735120>.

Thank you!

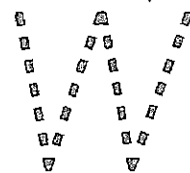
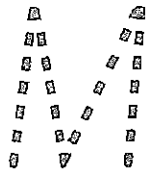
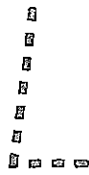
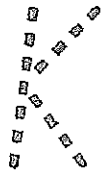
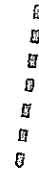

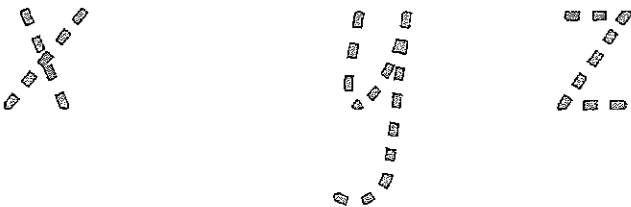
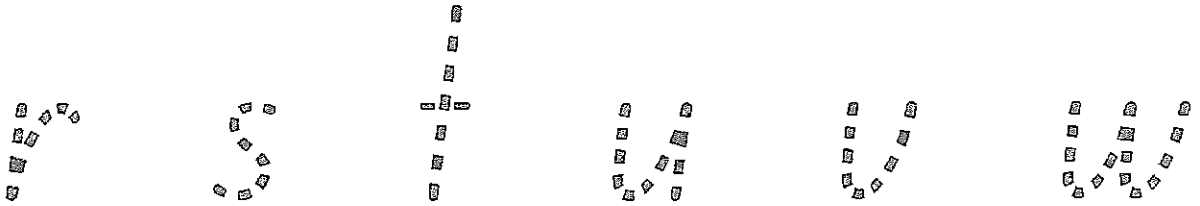
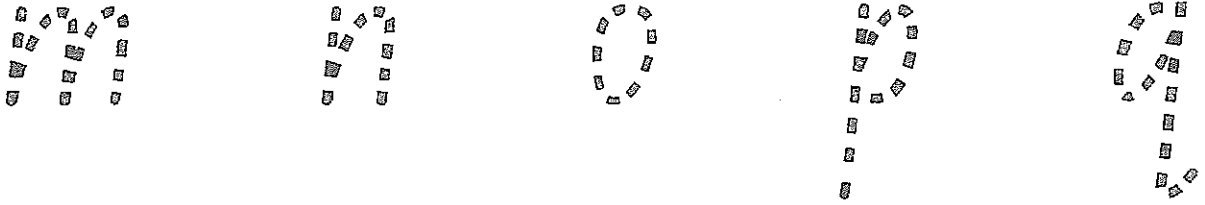
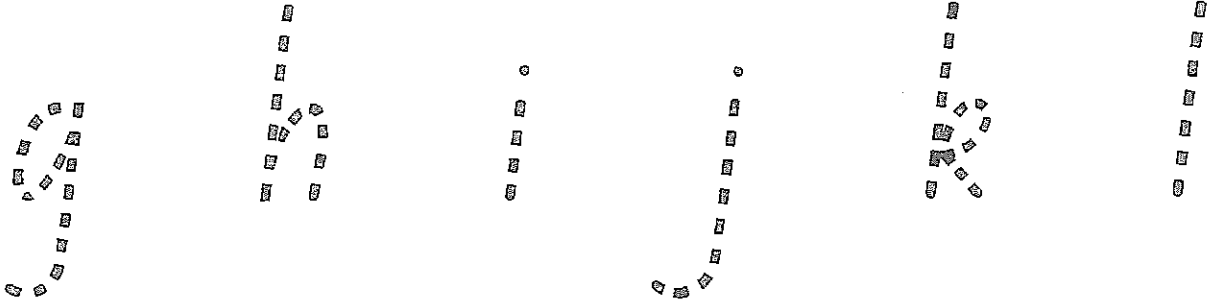
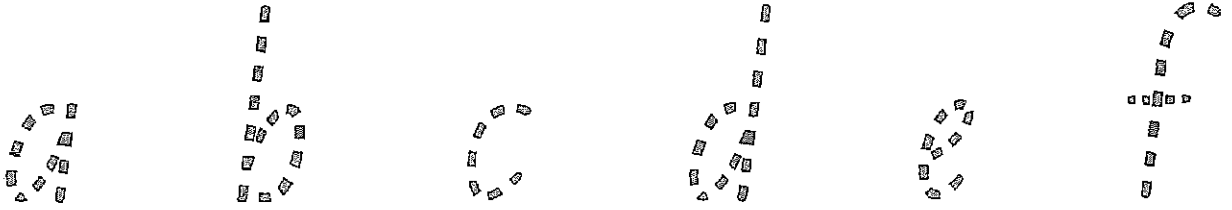

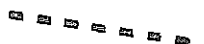
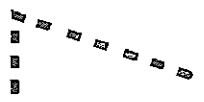
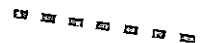
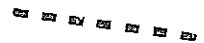
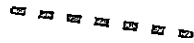
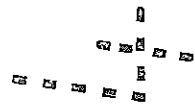
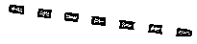
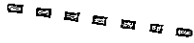
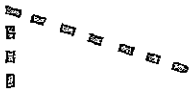

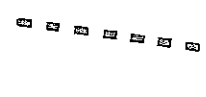
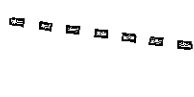

Numbers

Connect the dots from number 1 to number 27 to see an underwater creature!

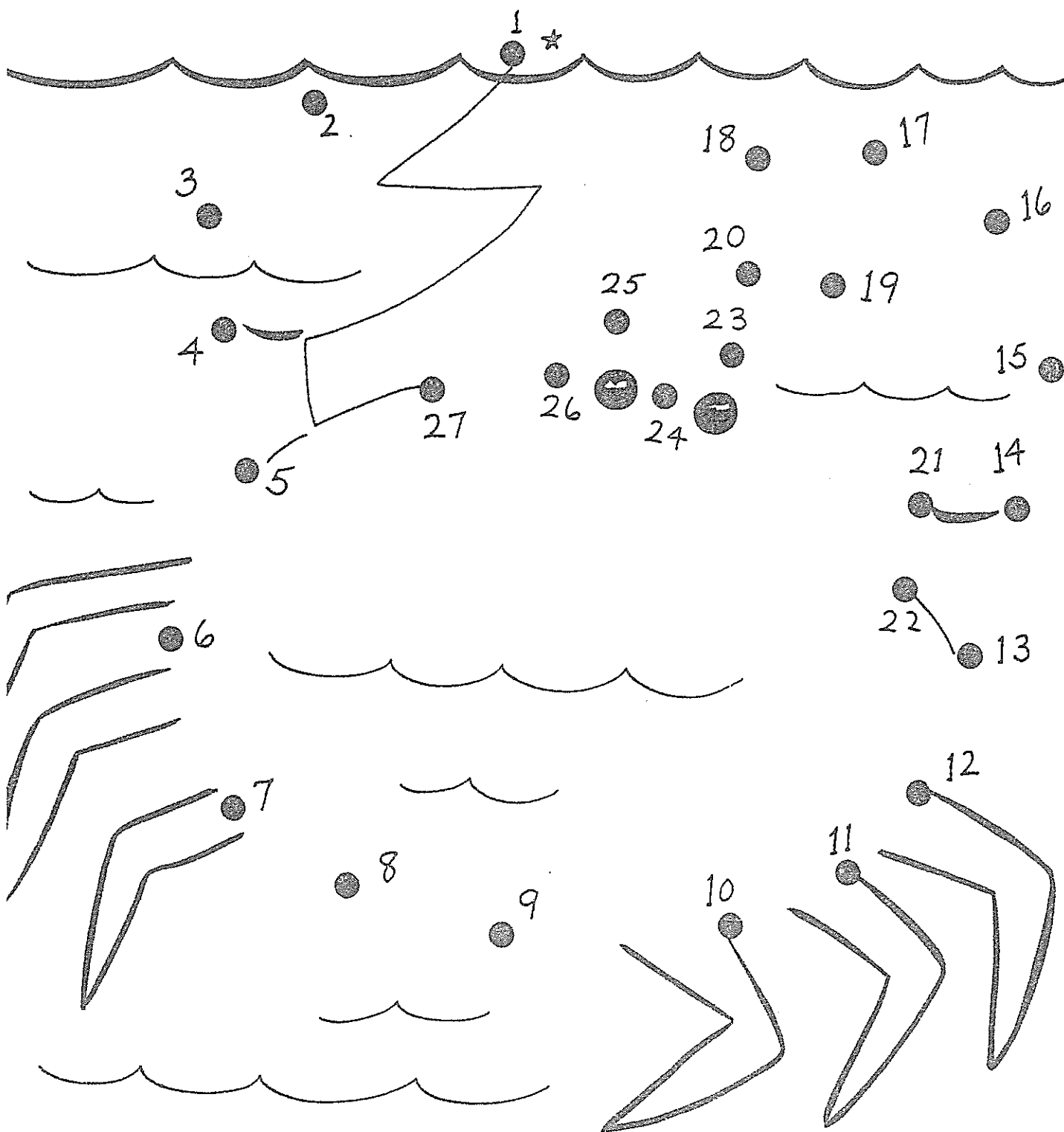

Feeding Time

Match each pet with the food it likes to eat!

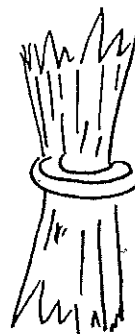
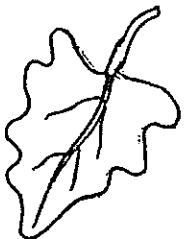
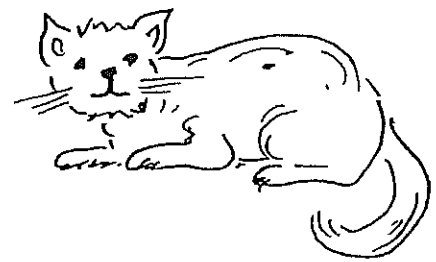
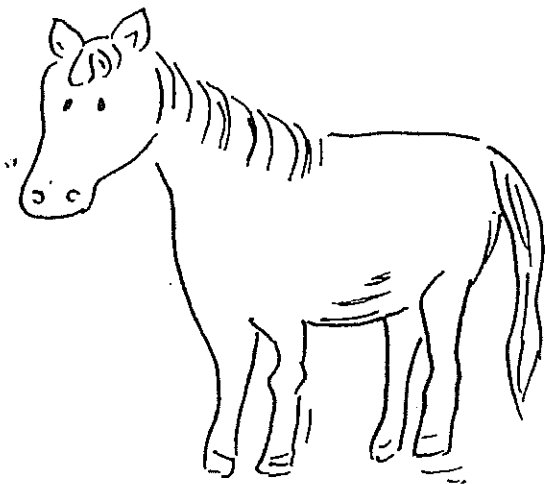
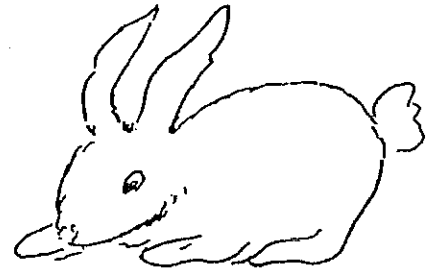
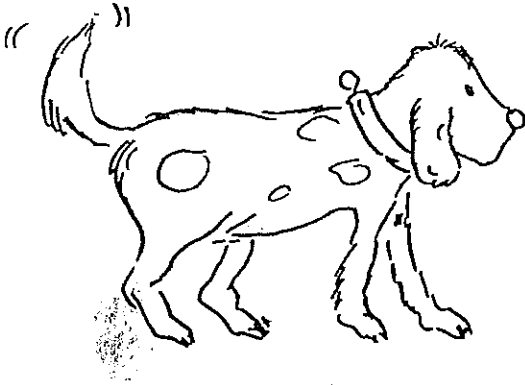

The Alphabet

Connect the dots from A to T to see what's gliding by!

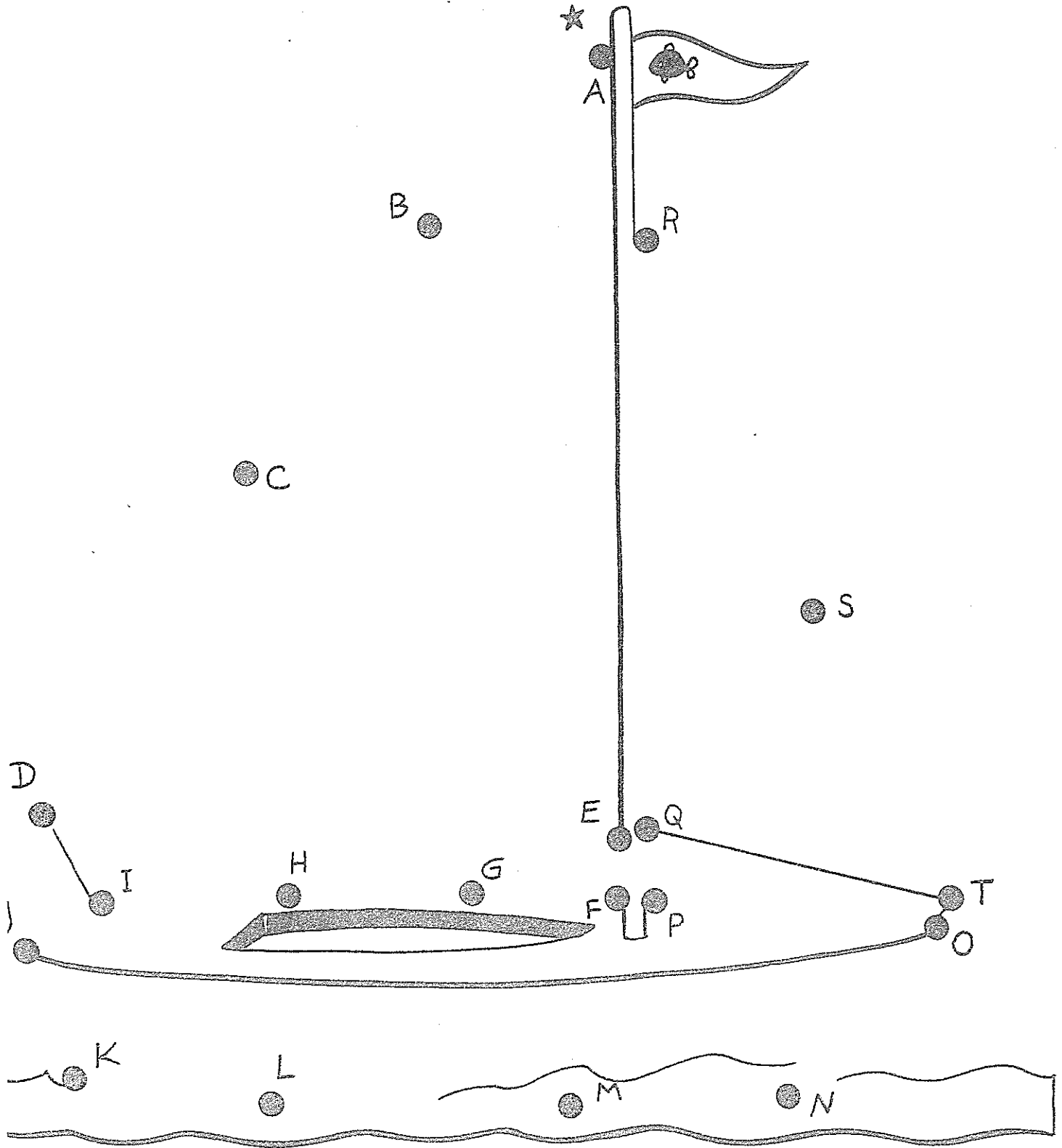

Easter Egg Hunt

Can you find the hidden eggs and count them?
Look at the picture and find all the eggs!

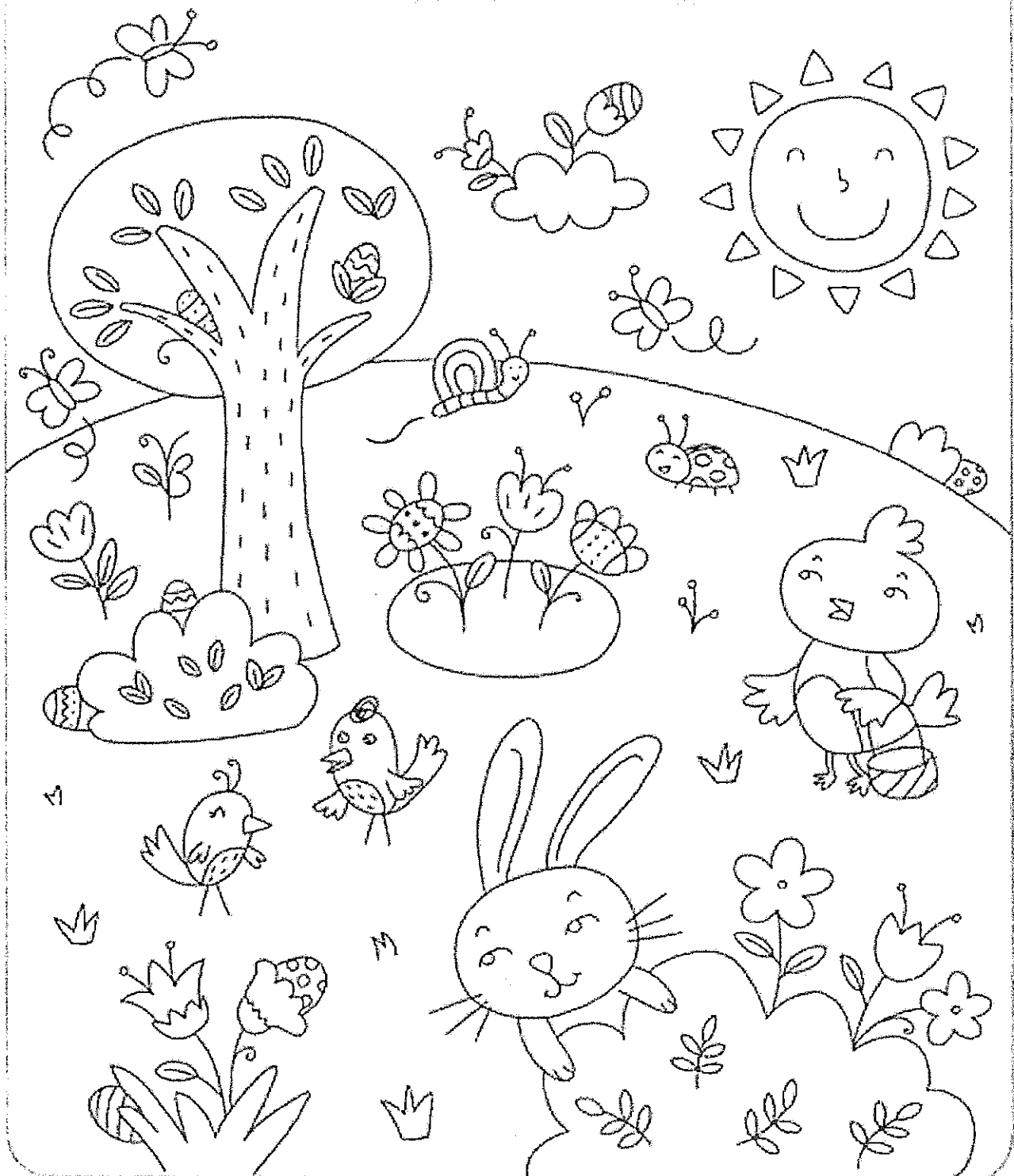

Name _____

Scissor Skills
Item 3477

Scissor Skills

Use your scissors to cut from the black square to the black dot.
Try and cut along the dotted line!

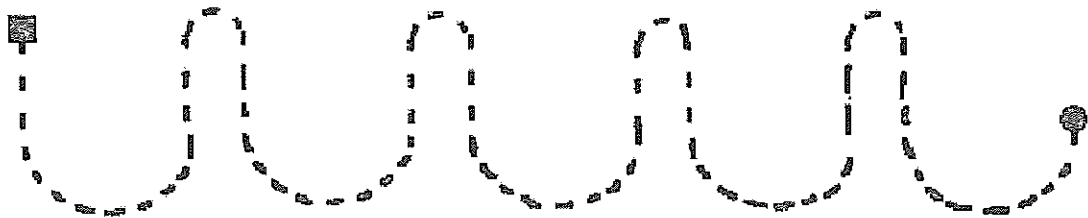
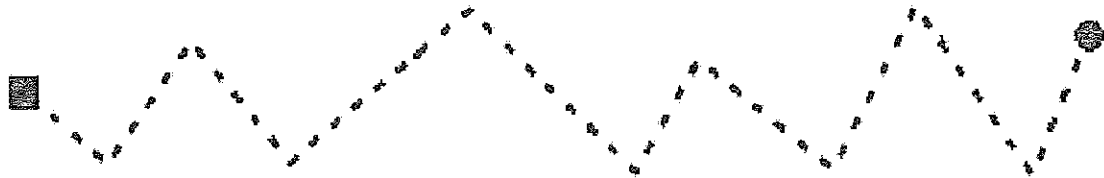

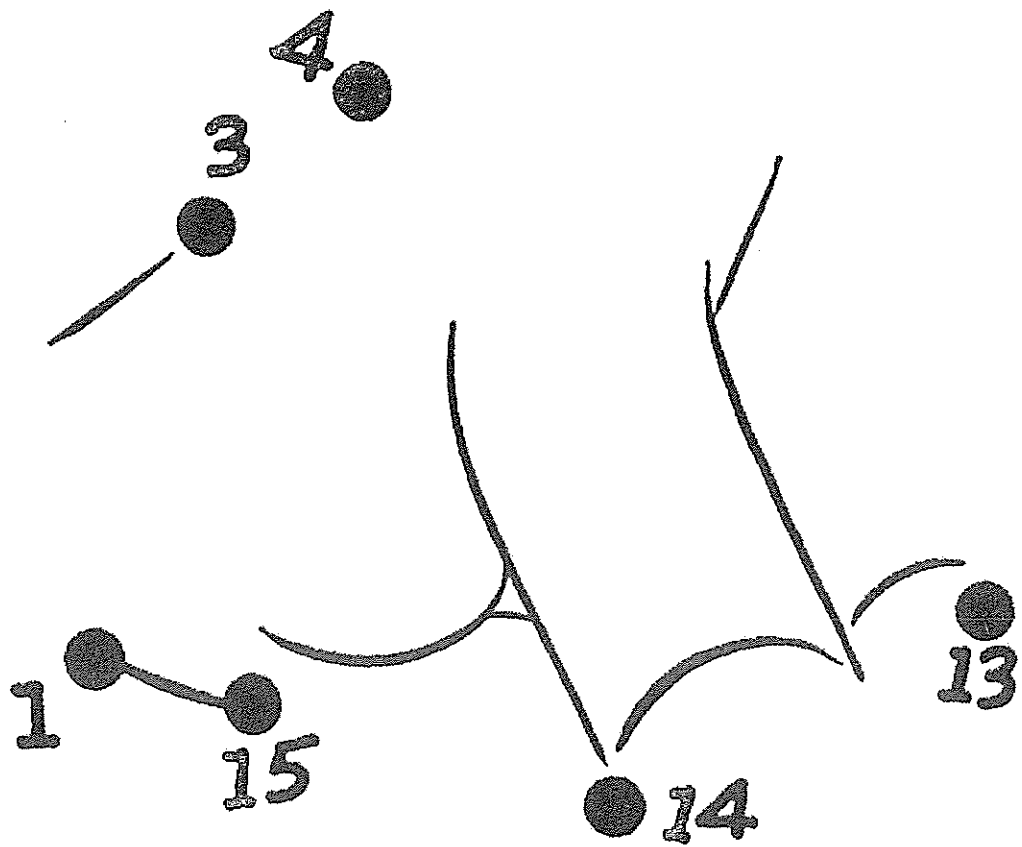
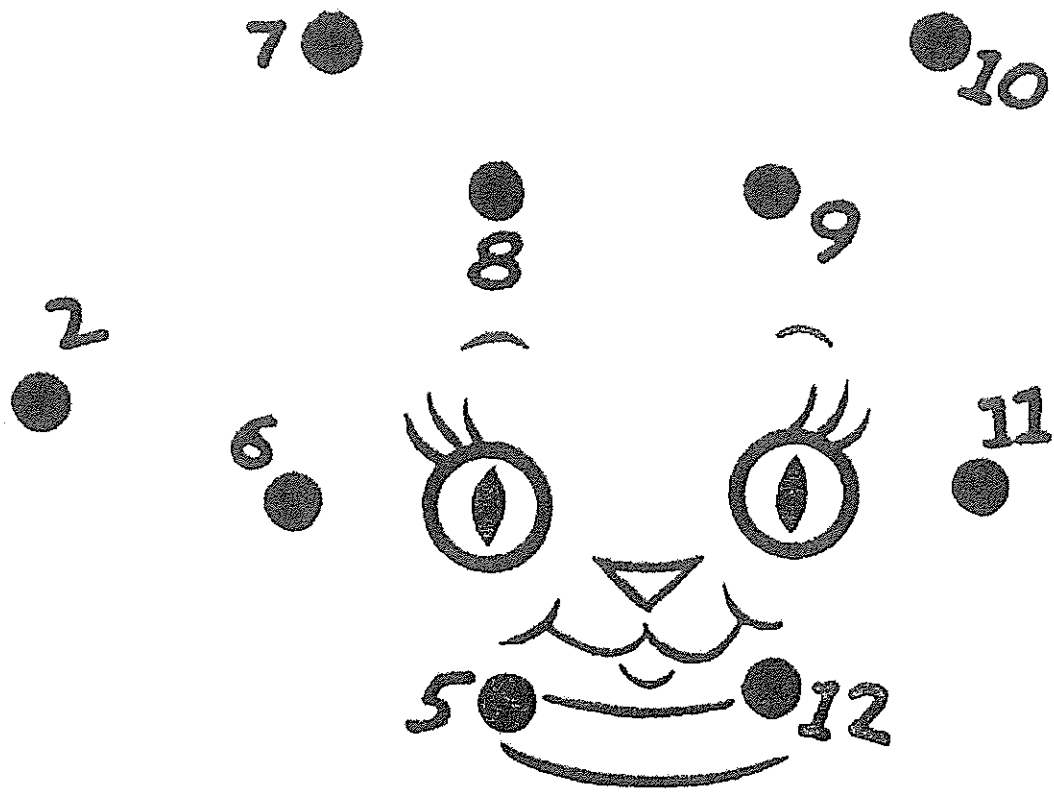

Spot 5 differences!

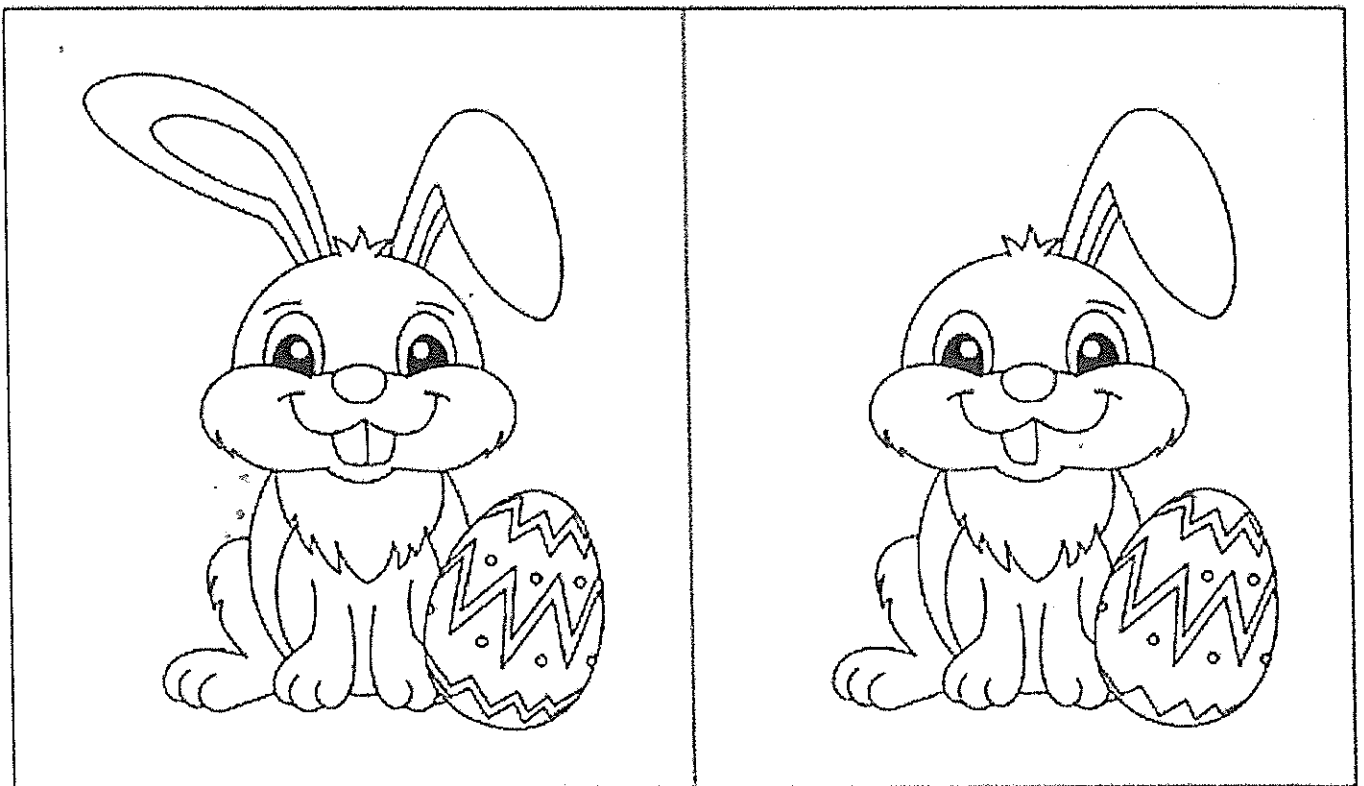
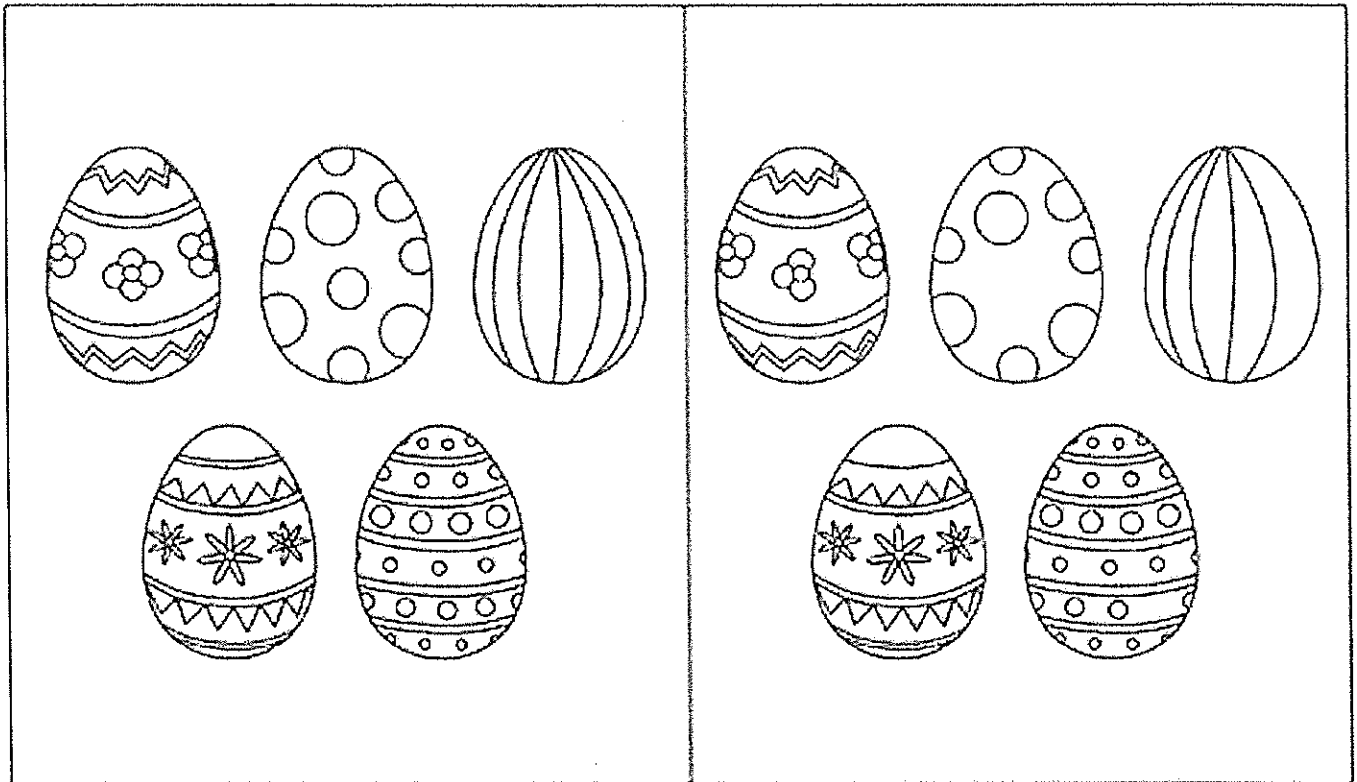

Numbers

Connect the dots from number 1 to number 12 to see who lives in this nest!

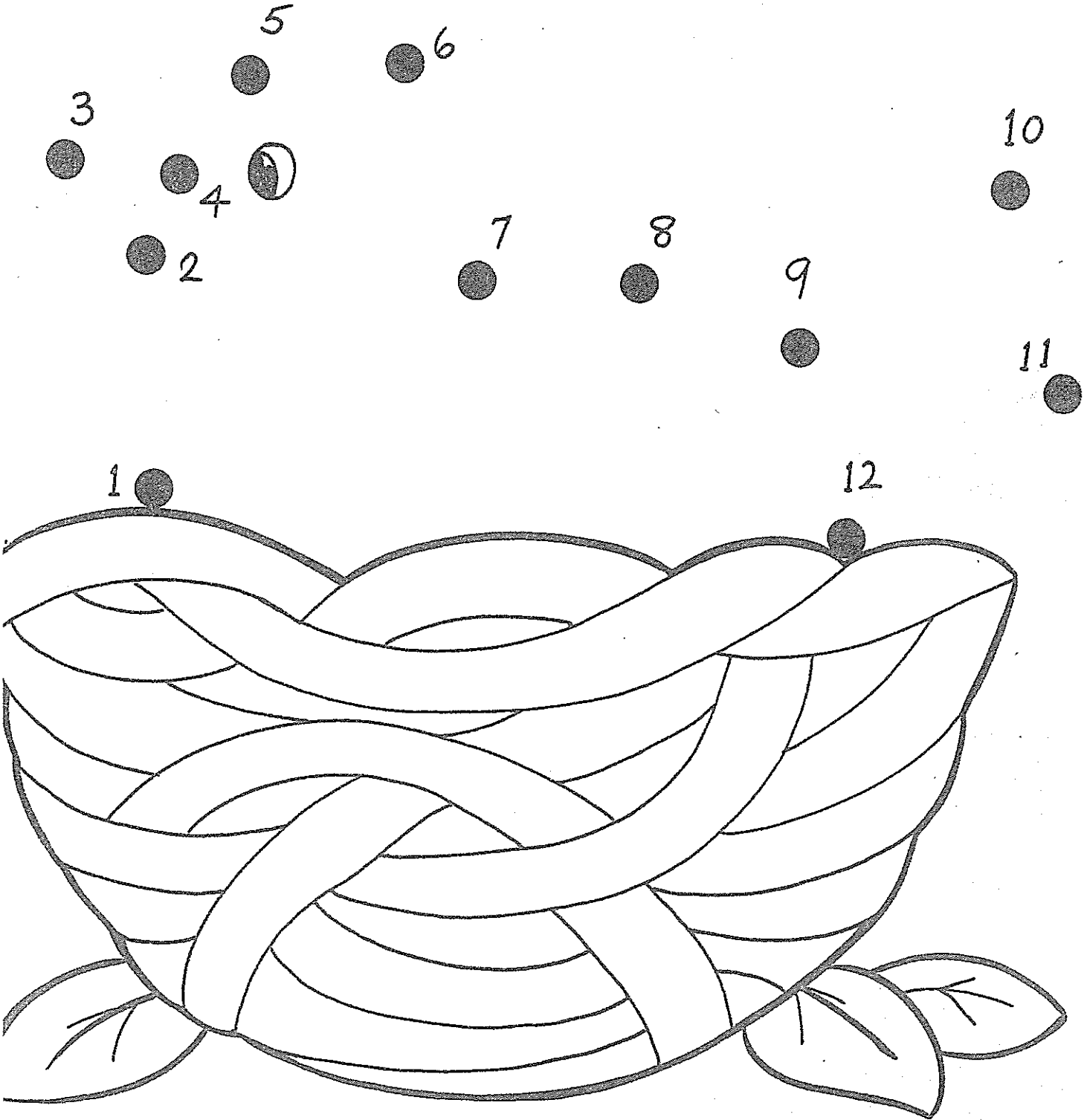

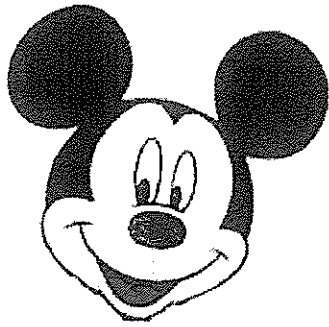

FACE

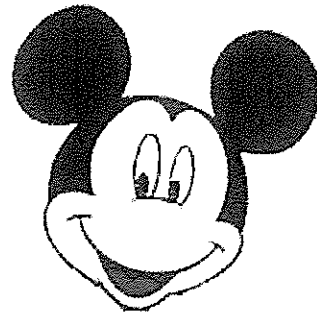

NOSE

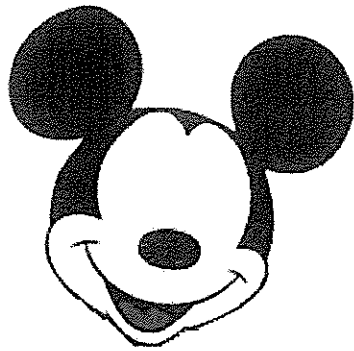

EYES

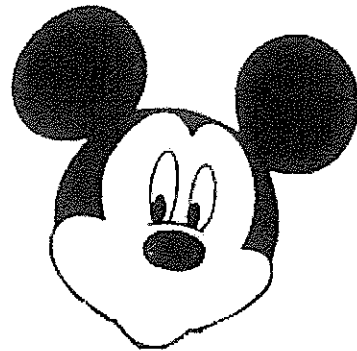

MOUTH

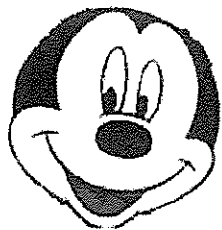

EARS

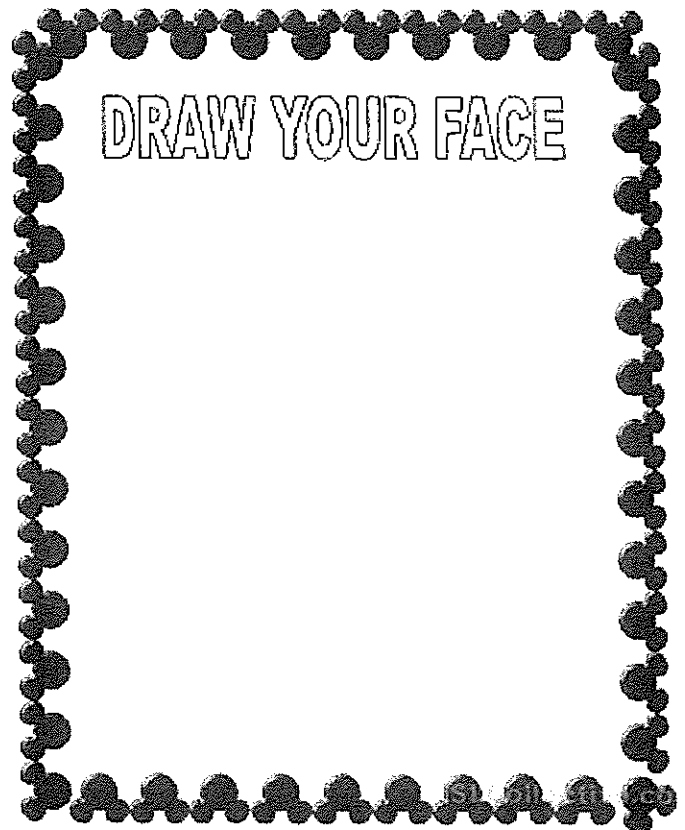

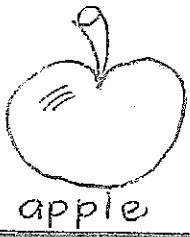

apple



rice

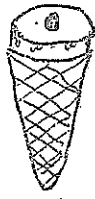

ice-cream



chips

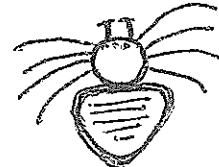

spider

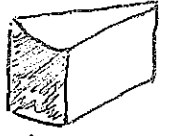

cheese

What do you like to eat?

I don't like to eat...

I like to eat...

